

Linear

# LINI Blade-S R020

## Fixture Guide

# KKDÖ

Indoor | Surface | Output up to 912lm/m (278lm/ft)

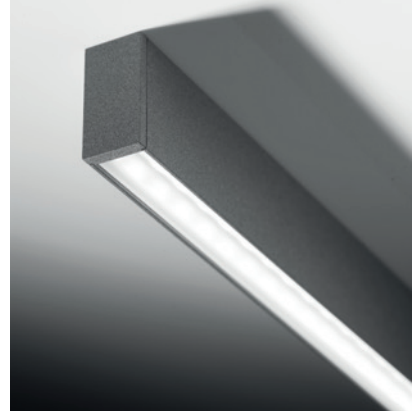

### Key applications

- ✓ Architectural detail
- ✓ Cabinet & furniture
- ✓ Ceiling
- ✓ Ceiling pendant
- ✓ Direct lighting
- ✓ Downlighting
- ✓ Interior
- ✓ Retail display
- ✓ Wall grazing

### Key features

- ✓ Custom lengths
- ✓ Constant Voltage (CV)
- ✓ Decorative
- ✓ Diffusion: homogenous
- ✓ Direct view
- ✓ Extensive CCT range
- ✓ IP40 dry area
- ✓ Lens options

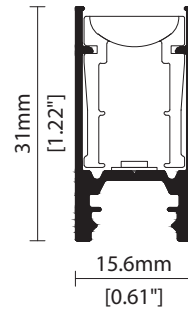

### MOUNTING METHODS



KKCP-10 Concealed clip



KKSU-06 Suspension mounting kit

Linear

# LINI Blade-S R020

## Specification sheet



<b>Dimensions</b>	H31/W15.6/L103-2020mm (H1.22/W0.61/L4.05-79.53in)
<b>PCB Cut-point</b>	41.7mm increment/2000mm max (1.64in increment/78.74in max)
<b>LED Pitch</b>	6.95mm-144LED/m (0.27in - 44LED/ft)
<b>Chip</b>	<b>s-line</b> <b>k-line</b>
<b>Cover/Optics</b>	Diffused (110°) / KKLN-01D Lens (15°) / KKLN-01U Lens (46°)
<b>CCT</b>	<b>s-line:</b> 1900K/2100K/2300K/2500K/2700K/3000K/3500K/4000K/5000K <b>k-line:</b> 1900K/2100K/2300K/2500K/2700K/3000K/3500K/4000K/5000K
<b>LED binning</b>	<b>s-line:</b> 2-step MacAdam ellipse <b>k-line:</b> 3-step MacAdam ellipse
<b>CRI</b>	≥92
<b>Lifetime</b>	50,000 hours @ 25°C (50,000 hours @ 77°F)
<b>Operating temp</b>	T <sub>a</sub> = -25 to 50°C (T <sub>c</sub> max = 70°C) T <sub>a</sub> = -13 to 122°F (T <sub>c</sub> max = 158°F)
<b>IP Rating</b>	IP40
<b>Finish</b>	Matt White/Matt Black/Matt Gray/Matt Silver/Bronze Powder coating
<b>Mounting</b>	Concealed clips or suspension kit
<b>Power feed</b>	Hardwire tails
<b>Control</b>	0-10V/1-10V/DMX/DALI



### LED Grading Key

#### Exclusive Grade

<b>s</b> <b>s-line*</b>	*KKDC tuned CCT range
2-step CCT range	

#### Base Grade

<b>k</b> <b>k-line</b>	3-step commercial range Energy Star CCTs
------------------------	---

<b>Power consumption</b>	<b>Supply voltage</b>	<b>Supply current</b>
20W/m (6.10W/ft)	24V DC	0.83A/m (0.25A/ft)

### Performance Data (3000K)

	R1	R2	R3	R4	R5	R6	R7	R8	R9	R10	R11	R12	R13	R14
<b>k-line</b>	93	97	97	91	92	94	91	83	63	91	91	74	94	98

	<b>15° (KKLN-01D)</b>	<b>Diffused Cover</b>	<b>CRI</b>	<b>R9</b>	<b>Rf</b>	<b>Rg</b>
<b>s-line</b>	912lm/m (278lm/ft) 45.6lm/W	424lm/m (129lm/ft) 21.2lm/W	93	63	-	-
<b>k-line</b>	860lm/m (262lm/ft) 43lm/W	400lm/m (122lm/ft) 20lm/W	92	62	-	-

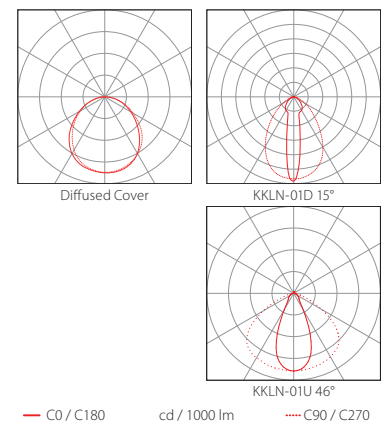
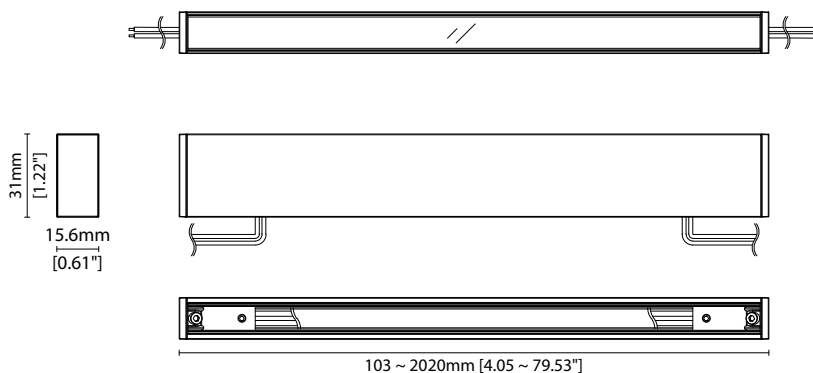

Data derived from independent UKAS/IESNA LM-79-08 accredited testing of production samples.

# LINI Blade-S R020

## Code Table



### FIXTURE

Model	Finish	Cover/Lens <sup>1</sup>	Grade <sup>2</sup>	LED	Colour (CCT)	Length Availability <sup>3</sup>	IP	Cable Length	Power Feed <sup>4</sup>	Input								
LINI Blade-S	Matt White Paint	MW	Diffused	C	s	R020 R020	1900K	19	m 103-2020mm 41.7mm increments	IP40 40	300mm/ 11.81"	0300	Single no sheath tail	S00X	DC 24V	g		
	Matt Silver Paint	MS	KKLN-01D 15°	S	k		2100K	21										
	Matt Grey Paint	MG	KKLN-01U 46°	R		2300K	23											
	Matt Black Paint	MB				2500K	25											
	Bronze Paint	BP				2700K	27											
						3000K	30											
3500K						35												
					4000K	40												
					5000K	50												

<sup>1</sup> Refer to **Cover/Lens Options** on **Options** pages

<sup>2</sup> Refer to **LED Grading Key** on **Specification sheet** page

<sup>3</sup> Refer to **Length Availability List** or enter total run length instead of length code

<sup>4</sup> Refer to **Power Feed Options** on **Options** pages

<sup>5</sup> Transparent suspension wire

### Code Example:

BS	-	MW	-	C	-	s	-	R020	-	35	-	m	520	-	40	-	0300	-	D00X	-	g
LINI Blade-S		Matt White Paint		Diffused				R020		3500K		519.8mm		IP40		300mm/11.81"		Double no sheath tail		24V DC	

### ACCESSORIES

#### Mounting Accessories

KKCP-10	Concealed Clip
KKSW-06	Suspension Mounting Kit

\* Refer to **Mounting accessories** on **Accessories** pages

#### Connection Accessories

KKCN-01	2 PIN male & female 50mm (1.97in) pair
KKCN-03	2 PIN male & female 300mm (11.81in) pair
KKCN-06	2 PIN 300mm (11.81in) extension lead

\* Refer to **Power feed** on **Accessories** pages

#### PSU/Driver

0-10V/1-10V/DALI/DMX

\* Refer to **Driver/PSU Options** page for details or provide requirement and KKDC to offer the suitable option

### LED ENGINE VARIANTS (LED STRIP TYPE)

Colour	LED	Lumen/m	Lumen/ft	W/m	W/ft	Spec Doc	Length	Increment
Single CCT	R007	475	145	7	2.13	LINI Blade-S R007	103-2020mm (4.05-79.53in)	41.7mm (1.64in)
	R014	965	294	14	4.27	LINI Blade-S R014	103-2020mm (4.05-79.53in)	41.7mm (1.64in)
	<b>R020</b>	<b>912</b>	<b>278</b>	<b>20</b>	<b>6.10</b>	<b>LINI Blade-S R020</b>	<b>103-2020mm (4.05-79.53in)</b>	<b>41.7mm (1.64in)</b>
Warm Dim/Dynamic White	R207	1102	336	16	4.88	LINI Blade-S R207	103-2020mm (4.05-79.53in)	83.3mm (3.28in)
RGB	501	Red: 105 Green: 225 Blue: 37 RGB: 325	Red: 32 Green: 69 Blue: 11 RGB: 99	15.6	4.75	LINI Blade-S RGB	103-2020mm (4.05-79.53in)	83.3mm (3.28in)

\* Performance data: A/s-line, KKLN-01 15° lens, 3000K

# LINE Blade-S R020

## Length Availability List



Length Code		Fixture Length <sup>1</sup>		LED Strip <sup>2</sup>		End Cap Dimension		Wattage (W)	Output (lm)
Metric	Imperial(US)	Metric	Imperial(US)	Metric	Imperial(US)	Metric	Imperial(US)		3000K (Test Data)
m0103	i0004	103mm	4.07in	83mm	3.28in	5mm	0.20in	1.67	72
m0145	i0006	145mm	5.71in	125mm	4.92in	5mm	0.20in	2.50	108
m0187	i0007	187mm	7.35in	167mm	6.56in	5mm	0.20in	3.33	143
m0228	i0009	228mm	8.99in	208mm	8.20in	5mm	0.20in	4.17	179
m0270	i0011	270mm	10.63in	250mm	9.84in	5mm	0.20in	5.00	215
m0312	i0012	312mm	12.27in	292mm	11.48in	5mm	0.20in	5.83	251
m0353	i0014	353mm	13.91in	333mm	13.12in	5mm	0.20in	6.67	287
m0395	i0016	395mm	15.55in	375mm	14.76in	5mm	0.20in	7.50	322
m0437	i0017	437mm	17.19in	417mm	16.40in	5mm	0.20in	8.33	358
m0478	i0019	478mm	18.83in	458mm	18.04in	5mm	0.20in	9.17	394
m0520	i0020	520mm	20.47in	500mm	19.69in	5mm	0.20in	10.00	430
m0562	i0022	562mm	22.11in	542mm	21.33in	5mm	0.20in	10.83	466
m0603	i0024	603mm	23.75in	583mm	22.97in	5mm	0.20in	11.67	502
m0645	i0025	645mm	25.39in	625mm	24.61in	5mm	0.20in	12.50	537
m0687	i0027	687mm	27.03in	667mm	26.25in	5mm	0.20in	13.33	573
m0728	i0029	728mm	28.67in	708mm	27.89in	5mm	0.20in	14.17	609
m0770	i0030	770mm	30.31in	750mm	29.53in	5mm	0.20in	15.00	645
m0812	i0032	812mm	31.96in	792mm	31.17in	5mm	0.20in	15.83	681
m0853	i0034	853mm	33.60in	833mm	32.81in	5mm	0.20in	16.67	717
m0895	i0035	895mm	35.24in	875mm	34.45in	5mm	0.20in	17.50	752
m0937	i0037	937mm	36.88in	917mm	36.09in	5mm	0.20in	18.33	788
m0978	i0039	978mm	38.52in	958mm	37.73in	5mm	0.20in	19.17	824
m01020	i0040	1020mm	40.16in	1000mm	39.37in	5mm	0.20in	20.00	860
m01062	i0042	1062mm	41.80in	1042mm	41.01in	5mm	0.20in	20.83	896
m01103	i0043	1103mm	43.44in	1083mm	42.65in	5mm	0.20in	21.67	932
m01145	i0045	1145mm	45.08in	1125mm	44.29in	5mm	0.20in	22.50	967
m01187	i0047	1187mm	46.72in	1167mm	45.93in	5mm	0.20in	23.33	1003
m01228	i0048	1228mm	48.36in	1208mm	47.57in	5mm	0.20in	24.17	1039
m01270	i0050	1270mm	50.00in	1250mm	49.21in	5mm	0.20in	25.00	1075
m01312	i0052	1312mm	51.64in	1292mm	50.85in	5mm	0.20in	25.83	1111
m01353	i0053	1353mm	53.28in	1333mm	52.49in	5mm	0.20in	26.67	1147
m01395	i0055	1395mm	54.92in	1375mm	54.13in	5mm	0.20in	27.50	1182
m01437	i0057	1437mm	56.56in	1417mm	55.77in	5mm	0.20in	28.33	1218
m01478	i0058	1478mm	58.20in	1458mm	57.41in	5mm	0.20in	29.17	1254
m01520	i0060	1520mm	59.84in	1500mm	59.06in	5mm	0.20in	30.00	1290
m01562	i0061	1562mm	61.48in	1542mm	60.70in	5mm	0.20in	30.83	1326
m01603	i0063	1603mm	63.12in	1583mm	62.34in	5mm	0.20in	31.67	1362
m01645	i0065	1645mm	64.76in	1625mm	63.98in	5mm	0.20in	32.50	1397
m01687	i0066	1687mm	66.40in	1667mm	65.62in	5mm	0.20in	33.33	1433
m01728	i0068	1728mm	68.04in	1708mm	67.26in	5mm	0.20in	34.17	1469
m01770	i0070	1770mm	69.69in	1750mm	68.90in	5mm	0.20in	35.00	1505
m01812	i0071	1812mm	71.33in	1792mm	70.54in	5mm	0.20in	35.83	1541
m01853	i0073	1853mm	72.97in	1833mm	72.18in	5mm	0.20in	36.67	1577

# LINI Blade-S R020

## Length Availability List



Length Code		Fixture Length <sup>1</sup>		LED Strip <sup>2</sup>		End Cap Dimension		Wattage (W)	Output (lm) 3000K (Test Data)
Metric	Imperial(US)	Metric	Imperial(US)	Metric	Imperial(US)	Metric	Imperial(US)		
m01895	i0075	1895mm	74.61in	1875mm	73.82in	5mm	0.20in	37.50	1612
m01937	i0076	1937mm	76.25in	1917mm	75.46in	5mm	0.20in	38.33	1648
m01978	i0078	1978mm	77.89in	1958mm	77.10in	5mm	0.20in	39.17	1684
m02020	i0080	2020mm	79.53in	2000mm	78.74in	5mm	0.20in	40.00	1720

<sup>1</sup> Actual total overall length of light fixture (LED strip + end caps + void/wire hole)

<sup>2</sup> Actual length of PCB strip

<sup>3</sup> Actual length of 2x end caps

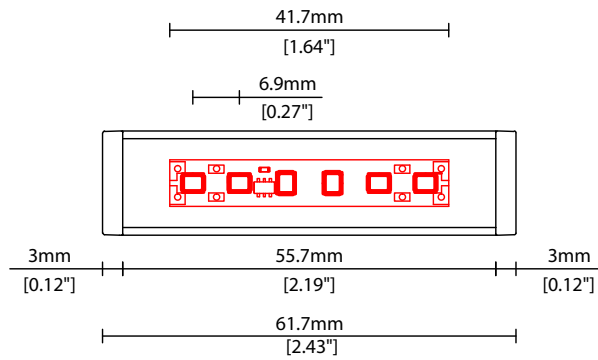

Linear

# LINI Blade-S R020

## Options

# KKDC

### COVER/LENS OPTIONS

\* Options are an integral part of the fixture ordering codes. Please refer to **Code Table** pages.



**C** Diffused Cover  
Polycarbonate finish  
W15.6/H31mm (W0.61/H1.22")

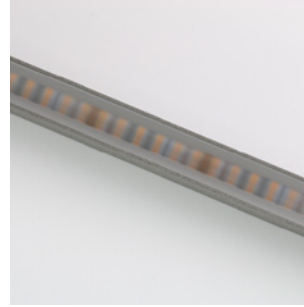
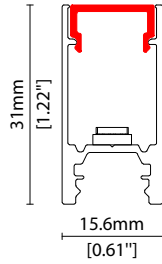

**S** KKLN-01D 15° lens  
15° beam linear lens,  
co-extruded PMMA  
W15.6/H31mm (W0.61/H1.22")

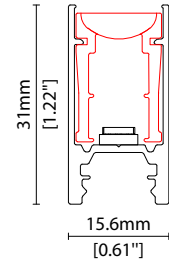

**R** KKLN-01U 46° lens  
46° beam linear lens,  
co-extruded PMMA  
W15.6/H31mm (W0.61/H1.22")

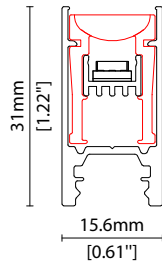

### POWER FEED OPTIONS

#### 0300 S00X 300mm (11.81") Single no sheath tail

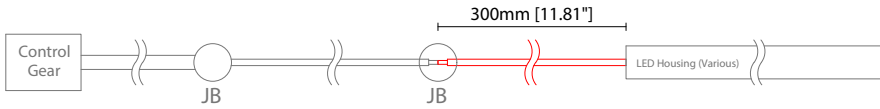

#### 0300 D00X 300mm (11.81") Double no sheath tail

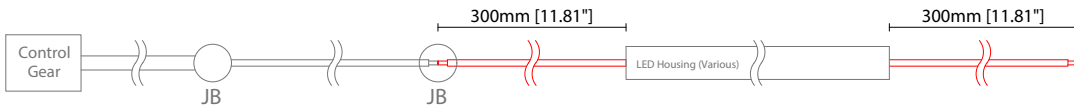

#### 1000 S00X 1000mm (39.37") Single no sheath tail

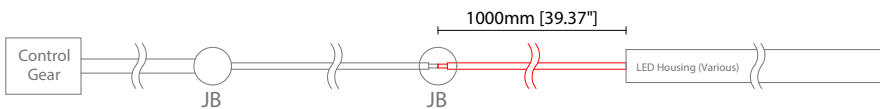

#### 1000 D00X 1000mm (39.37") Double no sheath tail

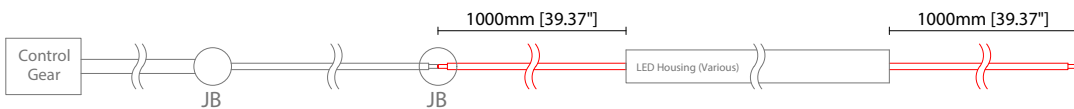

#### 3000 S00H 3000mm (118.11") Suspension single no sheath tail

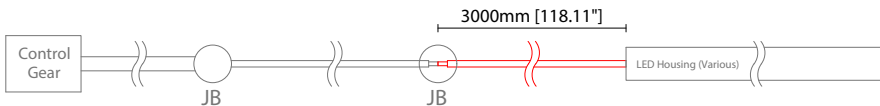

#### Key

Control Gear Power supply, sub-controllers & control systems

JB Junction box / cable connection

### MOUNTING ACCESSORIES

Note: Accessories are to be ordered separately with corresponding code shown below.



**KKCP-10**

Concealed clip  
(allow 2 per metre/40in)  
S/Steel finish  
L20/W15.6/H31mm  
(L0.79/W0.61/H1.22")

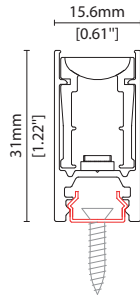

**KKSU-06**

Suspension mounting kit  
(allow 2 per metre/40in)  
S/Steel finish  
L14.9/W16/H3031mm  
(L0.59/W0.63/H119.33")

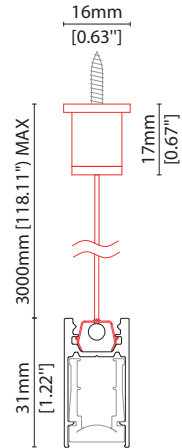

### POWER FEED

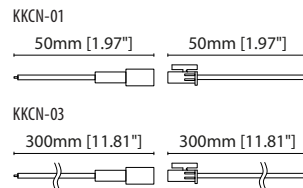
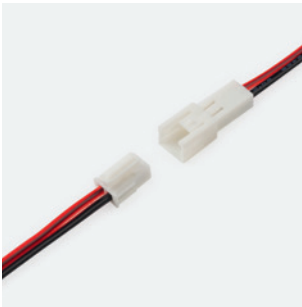

**KKCN-01** 50mm (1.97in) pair  
**KKCN-03** 300mm (11.81in) pair  
2 PIN male + female connector set

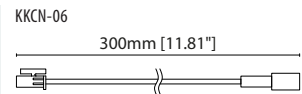

**KKCN-06**  
2 PIN 300mm (11.81in) extension lead

### KKDC CONTROL



IP20  
Plastic housing  
L170/W59/H29mm  
(L6.69/W2.32/H1.14in)

**KKDM-06** 1-10V  
visDIM dimmable sub-controller  
(4 x 8A max @ 12-36V)



IP20  
Plastic housing  
L170/W53.4/H28mm  
(L6.69/W2.10/H1.10in)

**KKSC-05** DMX  
visDIM dimmable sub-controller  
(4 x 5A max @ 12-36V)



Linear

# LINI Blade-S R020 Accessories

# KKDC

## KKDC CONTROL (CONTINUED)

---



IP20  
Plastic housing  
L170/W59/H29mm  
(L6.69/W2.32/H1.14in)

**KKDL-02** DALI

visDIM dimmable sub-controller  
(4 x 8A max @ 12-36V)



IP20  
Plastic housing  
L166/W53.4/H23mm  
(L6.54/W2.10/H0.91in)

**KKDL-03** DALI

visDIM dimmable sub-controller  
(4 x 5A max @ 12-36V)

### AVAILABLE PSU OPTIONS

Control Mode	PSU (Order Code)	Input Voltage AC	Output Voltage DC	Rated Output Current	Rated Power	Dim %	IP Rating
Switched	CEN-60-24	90-295V	24V	2.5A	60W	-	IP67
	HLG-60H-24	90-305V	24V	2.5A	60W	-	IP67
	HLG-100H-24	90-305V	24V	4.0A	100W	-	IP67
	HLG-150H-24	90-305V	24V	6.3A	150W	-	IP67
	HLG-240H-24	90-305V	24V	10A	240W	-	IP67
0-10V (1-10V)	PWM-40-24	90-305V	24V	1.67A	40W	100-0.15 (100-10)	IP67
	PWM-60-24	90-305V	24V	2.5A	60W	100-0.15 (100-10)	IP67
	PWM-90-24	90-305V	24V	3.67A	90W	100-0.15 (100-10)	IP67
	PWM-120-24	90-305V	24V	5.0A	120W	100-0.15 (100-10)	IP67
DALI	LIN100A1	120-277V	24V	1A per channel	100W	100-0.1	IP66/IP40
DMX RGB	LIN100A1	120-277V	24V	1.33A per channel	100W	100-0.1	IP66/IP40
DMX RGBW	LIN100A1	120-277A	24V	1A per channel	100W	100-0.1	IP66/IP40

### Flicker Free Options - Combination of PSU+ sub-controller

Control Mode	PSU (Order Code)	Sub-controller (Order Code)	Input Voltage AC	Output Voltage DC	Rated Output Current	Rated Power	Dim %	IP Rating PSU/ Sub-controller
0-10V or 1-10V	CEN-60-24	KKDM-06	90-295V	24V	2.5A	60W	100-0.9	IP67/IP20
	HLG-60H-24	KKDM-06	90-295V	24V	2.5A	60W	100-0.9	IP67/IP20
	HLG-100H-24	KKDM-06	90-295V	24V	4.0A	100W	100-0.9	IP67/IP20
	HLG-150H-24	KKDM-06	90-295V	24V	6.3A	150W	100-0.9	IP67/IP20
	HLG-240H-24	KKDM-06	90-295V	24V	10.0A	240W	100-0.9	IP67/IP20
DALI	CEN-60-24	KKDL-02/03	90-295V	24V	2.5A	60W	100-0.1	IP67/IP20
	HLG-60H-24	KKDL-02/03	90-305V	24V	2.5A	60W	100-0.1	IP67/IP20
	HLG-100H-24	KKDL-02/03	90-305V	24V	4.0A	100W	100-0.1	IP67/IP20
	HLG-150H-24	KKDL-02/03	90-305V	24V	6.3A	150W	100-0.1	IP67/IP20
	HLG-240H-24	KKDL-02/03	90-305V	24V	10.0A	240W	100-0.1	IP67/IP20
DMX RGB	CEN-60-24	KKSC-05	90-295V	24V	2.5A	60W	100-0.9	IP67/IP20
	HLG-60H-24	KKSC-05	90-305V	24V	2.5A	60W	100-0.9	IP67/IP20
	HLG-100H-24	KKSC-05	90-305V	24V	4A	100W	100-0.9	IP67/IP20
	HLG-150H-24	KKSC-05	90-305V	24V	6.3A	150W	100-0.9	IP67/IP20
	HLG-240H-24	KKSC-05	90-305V	24V	10.0A	240W	100-0.9	IP67/IP20

<sup>1</sup> The items shown above cover the most frequently used specification but does not exhaust the possible options

<sup>2</sup> PSU and/or driver can be chosen from the table, or KKDC may recommend the best option upon receipt of the controls requirement and installation environment

<sup>3</sup> Electrical shop drawing will include detailed information of PSU and relevant control drivers

<sup>4</sup> Cut sheets are available on the controls section of [www.kkdc.lighting](http://www.kkdc.lighting) or upon request